

Z and C Structural Profiles

OMCO manufactures an extensive line of structural Z and C shapes for many applications, including solar, buildings and industrial use. Our comprehensive Roll Forming Plus Operations allow us to efficiently supply in-line manufacturing of punched, pierced, notched material. If needed, we offer many off-line secondary value-added operations.

Call OMCO for custom hole patterns and additional sizes.

Available with Efficient In-Line and Off-Line Value-Added Operations



C Profiles

Style Group 1*

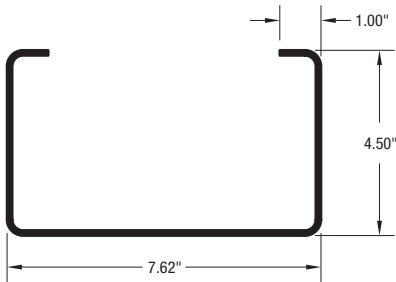
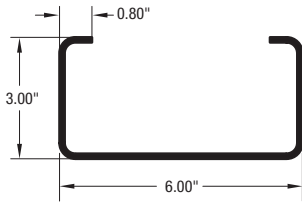

Material Thickness:

7, 10, 11 gauge

*Ideal for Solar Ground Posts

Style Group 2

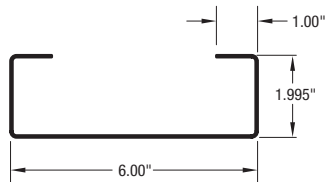
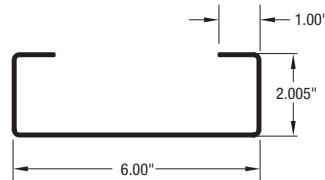
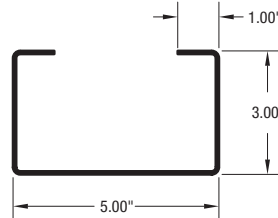
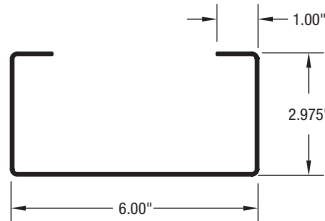
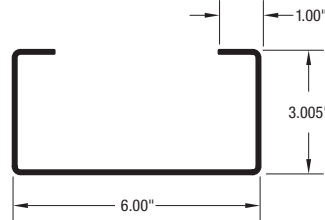

Material Thickness:

14, 16, 18 gauge

Style Group 3

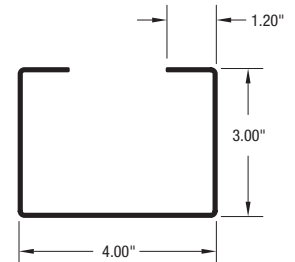
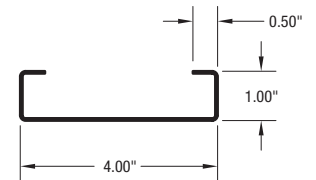
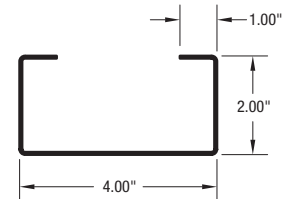
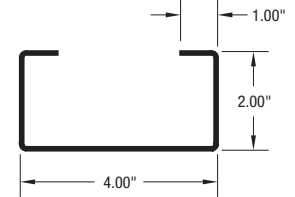

Material Thickness:

14, 16 gauge

Z Profiles

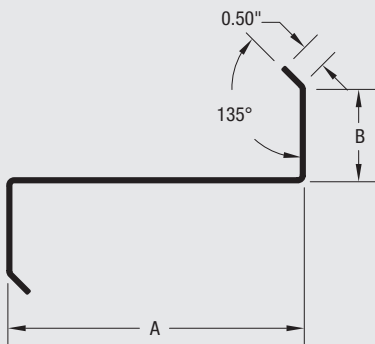

Material Thickness: 12, 14, 16 gauge

"A" Dimension: 6.0", 6.5", 7.0"

"B" Dimension: 1.87", 2.0", 3.0", 3.5", 4.0"



30396 Lakeland Blvd.
 Wickliffe, OH 44092
 PH: 440.944.2100
 FAX: 440.944.8309
 email: sales@omcoform.com
 www.omcoform.com