

# Z and C Structural Profiles

OMCO manufactures an extensive line of structural Z and C shapes for many applications, including solar, buildings and industrial use. Our comprehensive Roll Forming Plus Operations allow us to efficiently supply in-line manufacturing of punched, pierced, notched material. If needed, we offer many off-line secondary value-added operations.

Call OMCO for custom hole patterns and additional sizes.

Available with Efficient In-Line and Off-Line Value-Added Operations



# C Profiles

## Style Group 1

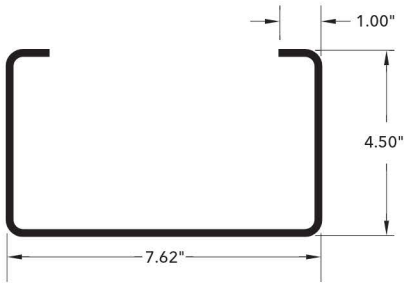
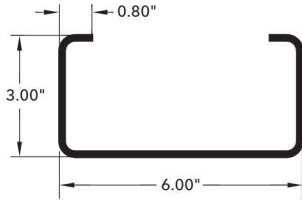

**Material Thickness:**

7, 10, 11 gauge

*\* Ideal for Solar Ground Posts*

## Style Group 2

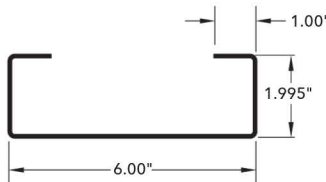
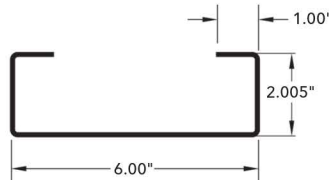
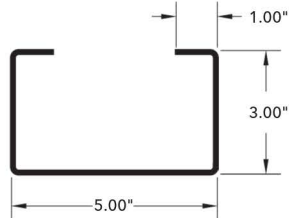
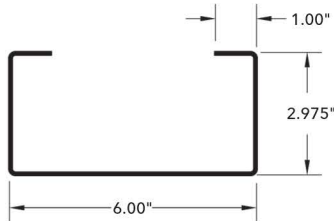
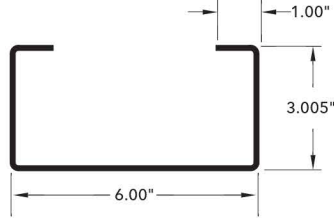

**Material Thickness:**

14, 16, 18 gauge

## Style Group 3

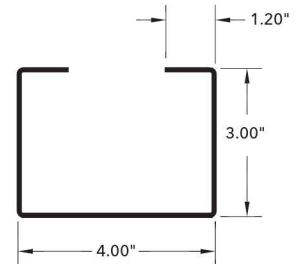
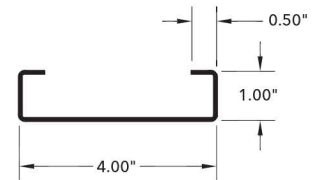
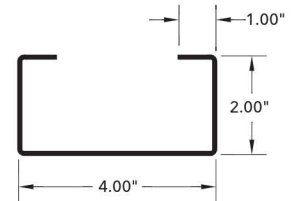
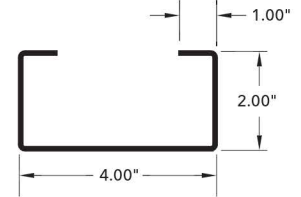

**Material**

**Thickness:** 14, 16

gauge

# Z Profiles

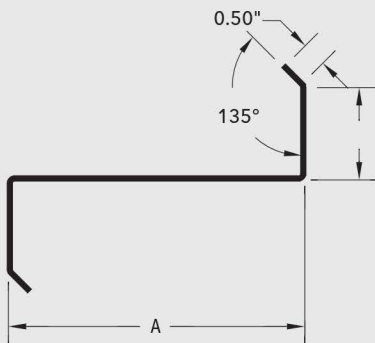

**Material Thickness:** 12, 14, 16 gauge

**"A" Dimension:** 6.0", 6.5", 7.0"

**"B" Dimension:** 1.87", 2.0", 3.0", 3.5", 4.0"